

# HOW TO BOTTOM A WELTED SHOE BY HAND

683  
WEST

By FRANK L. WEST  
Head of Shoemaking Division



TUSKEGEE NORMAL AND INDUS-  
TRIAL INSTITUTE

## PREFACE

In these lessons I have tried to explain by illustrations and as few words as possible the different steps which are taken in putting together a plain welted shoe by hand. Different shoemakers may have different ideas about the same operations, but the ultimate results, namely, neatness, comfort and durability, are what all are after. After seventeen years of practical work and teaching combined, I have found that the methods which follow give the desired results.

Yours very truly,

*Frank J. Wlex*

*Mrs. J. B. Wlex  
1912*

*6/30802*

Institute Press  
Tuskegee Institute, Alabama  
1912

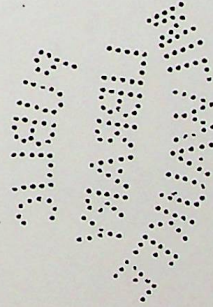

## HOW TO BOTTOM A WELTED SHOE BY HAND

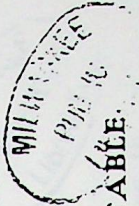

### SOME FACTS ABOUT COMFORTABLE, EASY WEARING SHOES

Easy wearing shoes are generally the result of much thought on the part of the workman, beginning with the selection of the last. The last should be one that is as nearly the shape of the foot as possible. Square toe lasts do not always insure comfort. The width of the ball and heel of a last has equally as much to do with the shoe being comfortable as the width or shape of the toe. It is therefore best that the shoe be made on a last that is quite wide enough for the foot from heel to toe.

The foot sets square on the insole of an easy wearing shoe; whenever the foot begins to slip and rest on one side of the insole the comfort is lessened.

The counter of a shoe should never bulge over the heel seat. The shank of the shoe should be wide enough, especially on the

Copyright, 1912  
By Frank L. West

outside. The sole on the outside should always be wide enough. The sole at the toe should not be wider than it is on the inside ball. The soles should not make a squeaking noise when being worn. The shoe should bend easily when walking, especially across the ball. The tread of the shoe should be as smooth as rocking in a rocking chair. Work that is not neat often takes away the feeling of comfortableness. Tacks should never be placed and left when there is any liability of their ever working through to the foot.

All of these and even more things must be thought of before and while making a shoe. The fact that a shoe should be neat, comfortable and serviceable, should be constantly borne in mind by the workman.

The finish on the job is begun the very moment the start is made. One careless or thoughtless operation may make it impossible to finish the job with the desired results.

## PREPARATION OF THE COUNTERS

(See drawings on plate I)

In these pages I wish to explain how to make a normal welted shoe with a medium bottom. It is very necessary that one should get everything in proper shape before beginning to make a shoe; that is, counters, boxes, innersoles, and everything in order as it should be before starting. The sole and heel leather should be in case and put away so that it will not get out of shape before you are ready for it. All knives and other tools must be in first-class shape. The bench must be clear of all other material or work save that on which you are to work. The job should be started, if possible, in time to at least get the heels on and the edges rasped up before leaving for the day.

The first thing to get in order is the counters. The counters should be as wide as the vamp and about one-fourth inch longer than the heel. Diagram I shows the exact shape of

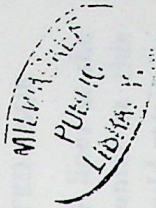

HOW TO BOTTOM A WELTED SHOE

the counter. Notice the heavy lines at the edges; these show that the counter at this point should be thinner and should retain its normal thickness in the center. Diagram II shows the section of the counter. Diagram III shows the position of the counter in the upper before beginning to last. Diagram IV shows section of the rear of the upper with the counter in its natural position.

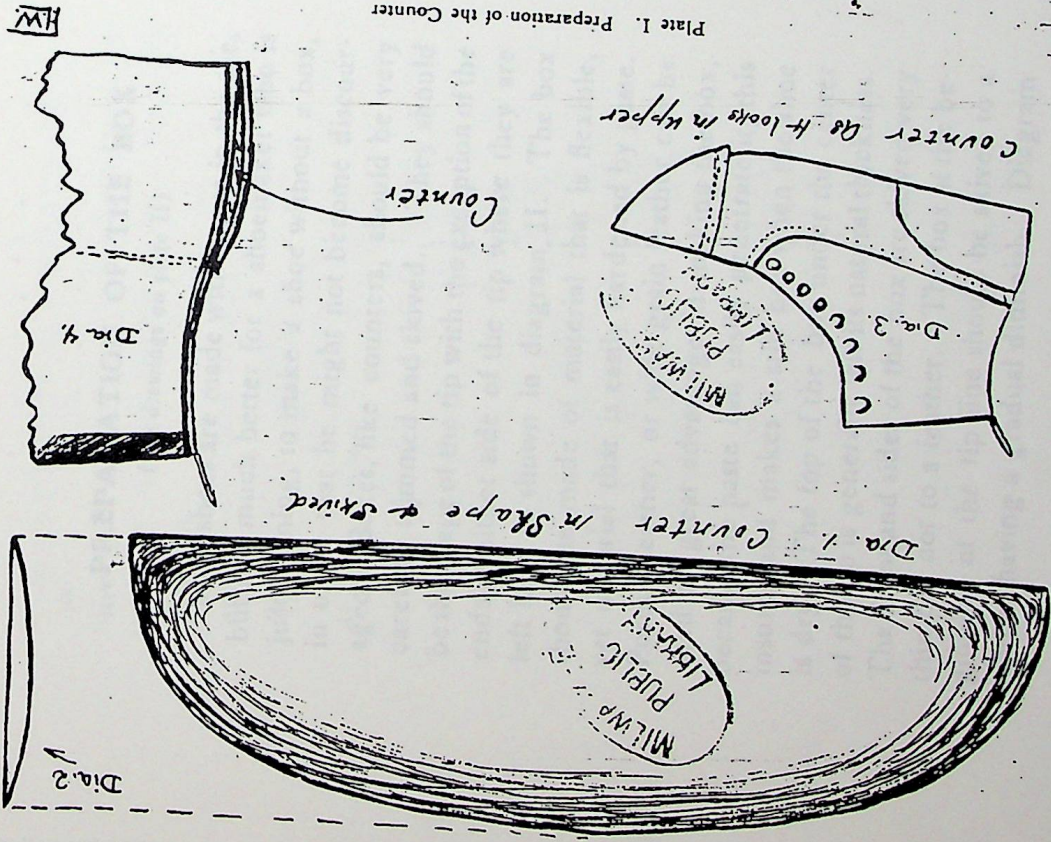

H.W.

## PREPARATION OF THE BOX

(See drawings on plate II)

Most shoes are made with boxes in the toe, but it is much better for a shoemaker who is just learning, to make a shoe without a box, in order that he might not become discouraged. Boxes, like counters, should be very carefully trimmed and skived. They should be the shape of the tip with the exception of the ends at either side of the tip where they are left long as shown in diagram II. The box should be made of material that is flexible, yet material that is easily hardened by paste. Porous leather, or wide-grain leather can be used to great advantage in making the box, because the paste can easily penetrate it; this insures and makes a stiff box when the shoe is dry. The top of the box under the center of the tip is generally left its natural thickness. The front and sides of the box are skived very thin but not to a feather. The box at the beginning of the tip line should be skived to a feather having a gradual diminish. Diagram

10

Diag. I.

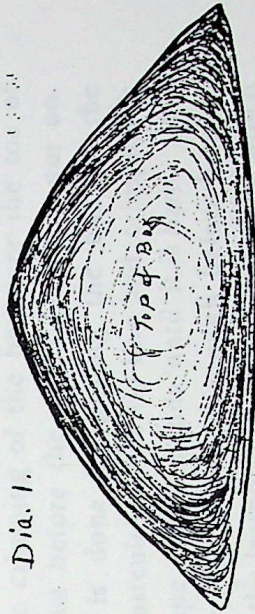

Box Trimmed & Skived

Diag. 2

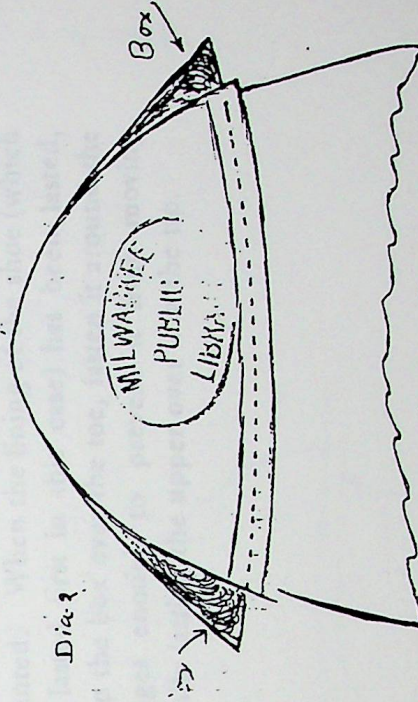

Box as it fits Toe of Upper

Preparation of the Box

### HOW TO BOTTOM A WELTED SHOE

III shows the top of an upper lasted with the long end of the box sticking out at the sides or tip line.

There are three ways in which a box can

Di a. 3.

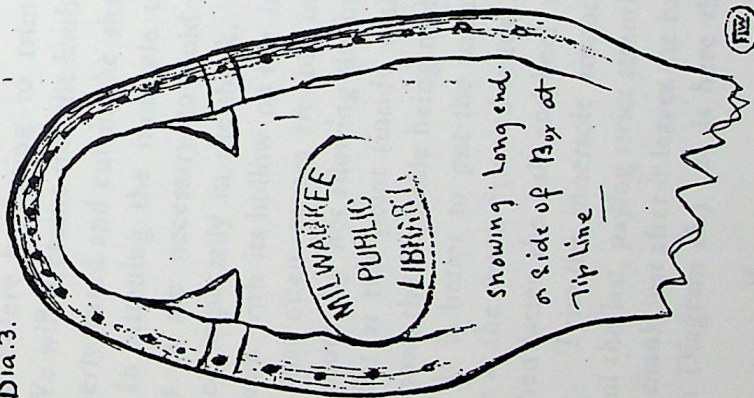

Preparation of the Box

12

### HOW TO BOTTOM A WELTED SHOE

be lasted or crimped over the toe. The one that is better for the beginner calls for moulding or crimping of the box over the toe of the last before the upper has been put on. This is done by placing the box on the last, fastening at the tip line and crimping it in shape. This stands until it is hard. It is better to do this long enough before hand to allow the leather to become stiff; after which it is taken from the last and put aside until wanted. When the lining of the shoe (which is lasted first in this case) has been lasted, slip the box over the toe, fasten it around the edges enough to prevent it from moving while lasting the upper over it at the tip.

13

## PREPARATION OF THE INNERSOLE

(See drawings)

The innersole being the foundation of the shoe, should be carefully fastened and molded to the last before beginning to trim it in shape. We will presume that the leather has been properly cased and cut in the shape of the last. In fastening the innersole use as many nails as are necessary to hold it in proper place, especially in the shank. It is the long shank with its hollow on the inside of the last that often causes trouble in the making of shoes; by not allowing the innersole to lay flat at this point (inside shank). Diagram I shows the innersole being molded to the last. It is better to put the strap on the innersole at the shank first and fasten it at this point, then fasten the ball and heel, and lastly the toe. Trim the innersole smoothly and in shape of the last, paying strict attention to the inside shank just after it leaves the ball. (See arrow in Diagram II.) It is here that

14

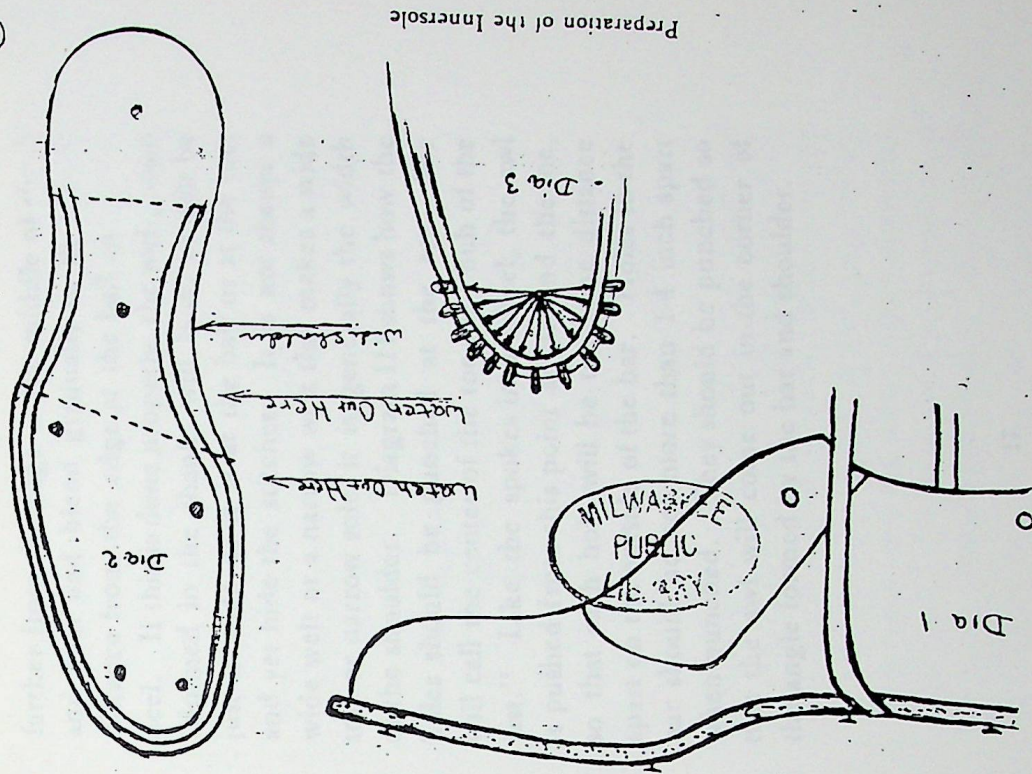

the shoe often seems too large or the inner-sole sticks out from under the foot if much care is not taken. Often the wearer finds himself trying to get his foot on top of the innersole, when the innersole itself is really larger than the sole of the foot at this point. There is nothing to indicate how small the shank should be, except the width of the ball, and the width of the front part of the heel. The innersole will have to be trimmed to a good proportion between these two points. It is here that taste is used. The small part of the shank, however, is seldom wider than the front of the heel. In cutting the bar for the innersole one must bear in mind two things:

- 1 At the toe the shoulder will have to be wide enough to hold both, the upper and box (when there is to be a box), and at the same time give the shoe the same shape the shoulder gives at the side of the shoe where there is no box.
2. In the shank, the stitches are not to be seen generally on shoes, and the bar at this point will have to be cut, generally 3-16 inch

farther from the edge at the middle of the ball and heel and blend gradually to its distance from the edge at the ball and heel. If this is done properly, the welt, when trimmed in the shank, will look, or will be just as wide as it is at the ball or at the toe, and yet hide the stitches. It is not always a wide welt or a narrow welt that makes a wide sole or narrow sole, it is generally the width of the shoulder. Diagram III shows how the holes should be punched at the toe. We will call the center of the toe the "hub of the last." Like the spokes in a wheel, the awl is pushed from this point all around the toe, so that each hole will be the same distance apart on the outside of the bar. Holes in the bar should be not more than 1-4 inch apart when punched. They should be punched so that the awl will come out in the corner of the angle formed by the bar and shoulder.

## LASTING THE UPPER

Lasting is considered to be, and is, one of the most particular operations in making a shoe. This operation is so delicate that two shoes when lasted over the same last by two different men will have a decided or different feeling. No two people pull the pinchers with the same touch or tension. There will be a difference somewhere. We come to the

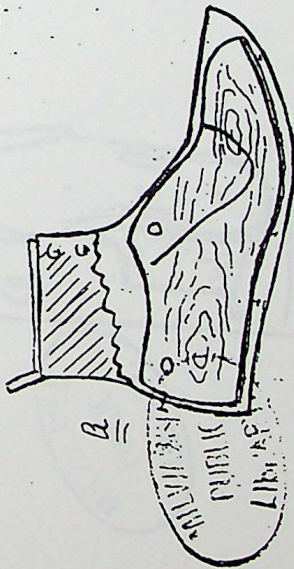

Lasting the Upper

conclusion, then, that one person should, at least, last shoes that are to be mates, or shoes that are to be worn by the same person. Hand lasting is considered the best.

Before beginning to last a shoe, the upper

## HOW TO BOTTOM A WELTED SHOE

should be carefully inspected to avoid any unnecessary work. Very often uppers are compelled to be taken from the last because of some little trouble which might have been detected before beginning, if the workman had been careful to inspect the upper beforehand. You should see that the counter is in straight and well made paste evenly distributed over it on both sides and the innersole

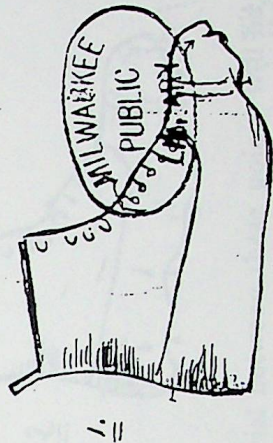

is fastened well to the last; you should see that there is soap stone, tallow, or something of the kind rubbed on the last at the heel and toe so that there will be no sticking when the last is taken from the shoe. Shoes often stick to the last (if this is not done) at the toe and at the heel. Many good shoes are often ruined

## HOW TO BOTTOM A WELTED SHOE

because of the workman not taking this precaution.

To begin lasting: first place the upper over the last as shown in Diagram A, allowing the heel of upper and last to be about even. If the upper is properly cut there will be an al-

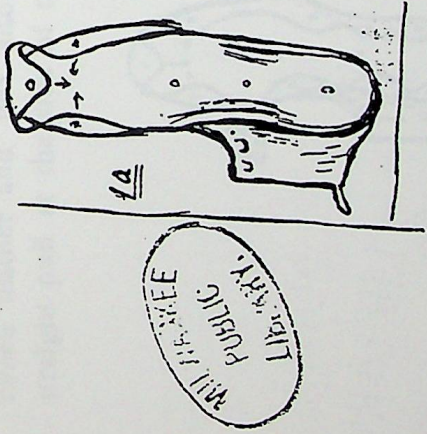

lowance of about 1-2 inch at the toe and all around for lasting. First pull the upper over at the toe and fasten with one nail. The next pulls are at the tip line on either side as shown in Diagrams I and I-A. It is now time to see that the upper is exactly straight before going

20

## HOW TO BOTTOM A WELTED SHOE

further. The material that is between the tip line and the center of the toe must be crimped in smoothly after the offset lasting; which is done by pulling the upper down just where the shank begins, on both sides, as shown in Diagram II, arrow 1. This will determine just how straight the shoe will be when lasted between the shank and the tip line. The



material between these points will be evenly distributed afterwards. Next pull down the shank and heel as shown in Diagrams II and II-A. The surplus between the tip line and the toe must now be divided and lasted so that there will be no bulging of material out of its own place. You will note that in this case no box was put in. When the box, which must have been crimped in shape, is

21

### HOW TO BOTTOM A WELTED SHOE

used, the lining and leather at the toe is lasted down smoothly. After the offset lasting the leather at the toe is pulled back and the paste is applied to lining, after which the box is slipped over toe and the leather lasted. Make sure that paste is well distributed between leather and box also. There is a straight pull at the side of the toe, pulling

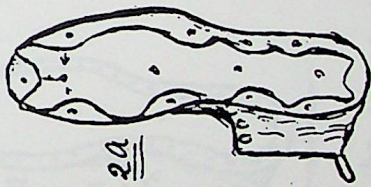

towards the hub of the toe. All pulling must be toward the hub with a slight twisting toward the preceding pull or nail. When placing nails try to place them in their permanent

### HOW TO BOTTOM A WELTED SHOE

position so that they will not have to be replaced. Replacing means the loss of time which might have been saved.

Next, last down the material between the toe or tip line and the ball, distributing it very carefully. Next last down the material between the ball line and heel line; be sure to pull the upper at right angles to the vamp line, beginning where the ball and shank

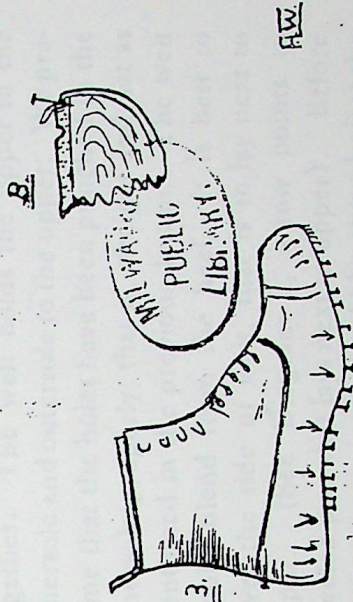

meet and ending at the end of the heel seat. Arrows on Diagrams II and III show just the direction in which the upper should be pulled at all points. The last part to be crimped is the heel. Be careful to see that the lining

#### HOW TO BOTTOM A WELTED SHOE

at the heel is not wrinkled. If the lining and upper are the same length it can be easily determined whether or not there will be wrinkles by having the upper and lining the same length before beginning the crimping. Be sure that all nails around the bar of the

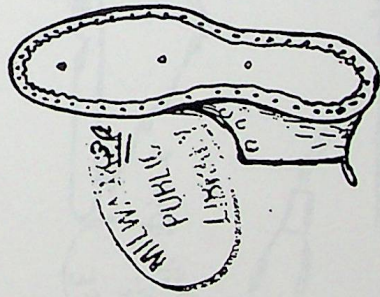

shoe are placed in the angles of bar and shoulder on innersole. See Diagram B. After the shoe is lasted be sure and mould the counters and tips in shape before the shoe is trimmed.

#### PUTTING ON THE WELT

Welting is a very particular operation; being a part of the foundation of the shoe it necessitates strong, level and accurate work. The welt leather, like sole leather, must be in good temper, that is, moist and flexible, because it has to be pulled well to all curves of the last and serves to hold the whole shoe together. The welt holds the upper to the innersole and outsole to the upper. We presume that the holes have been punched in the innersole properly; that is, straight and flat as mentioned in the previous lesson. The welt should blend from the heel. It is best to bevel the side of welt, that is to lay next to upper. (See Diagram I, arrow points to beveled part that lays next to upper). Before beginning to sew, it should be skived off at the end about one-half inch, or enough to take two stitches at the end. The first stitch (see Diagram IV) is made in the innersole and upper, pushing the awl from the inside through the upper. The next stitch is made

### HOW TO BOTTOM A WELTED SHOE

catching the end of the welt and is overcasted on the welt. The greatest pulling is done with the right hand. For instance, if the workman is right-handed, he pulls harder on the outside stitch, making sure, however, to pull the inside seam up well and tight. Over-casting on the outside or on the welt helps the stitches to lay flat and prevents pulling through. In pushing the awl through, every precaution must be taken to guard against a round or high seam. To prevent such a seam the awl should be pushed through the bar so that it will come out directly in the corner of angle (as shown in Diagram III) of the bar and shoulder. It is absolutely necessary that the upper be lasted and held in proper place here (at the bar) so there will be no straining while stitching by trying to pull it close to the bar. Diagram II shows upper held in its proper place in angle of bar and shoulder. When the upper is out of place and tacks placed on top of the bar, the upper is often torn between the shoulder and bar by pulling it to its proper place.

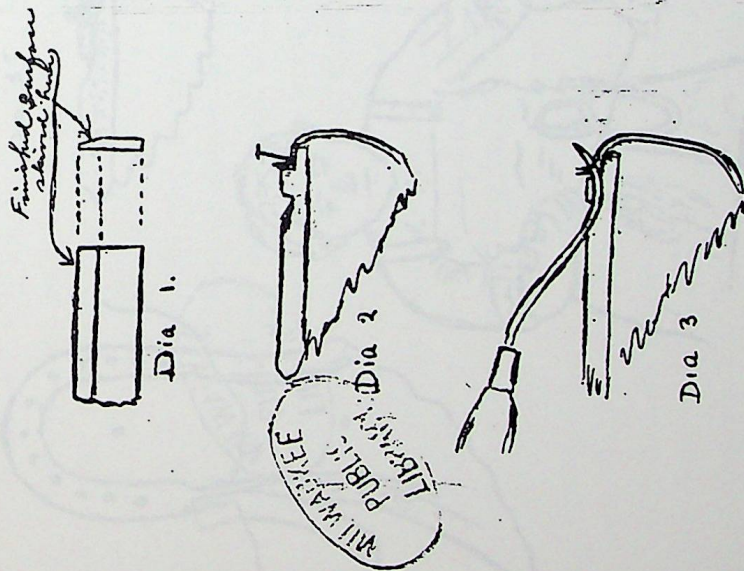

### HOW TO BOTTOM A WELTED SHOE

This will be avoided if the tacks are set right when lasting. After the welt has been stitched, it should be trimmed close to the bar (see Diagram V) and straightened before allowing it to dry, especially around the toe.

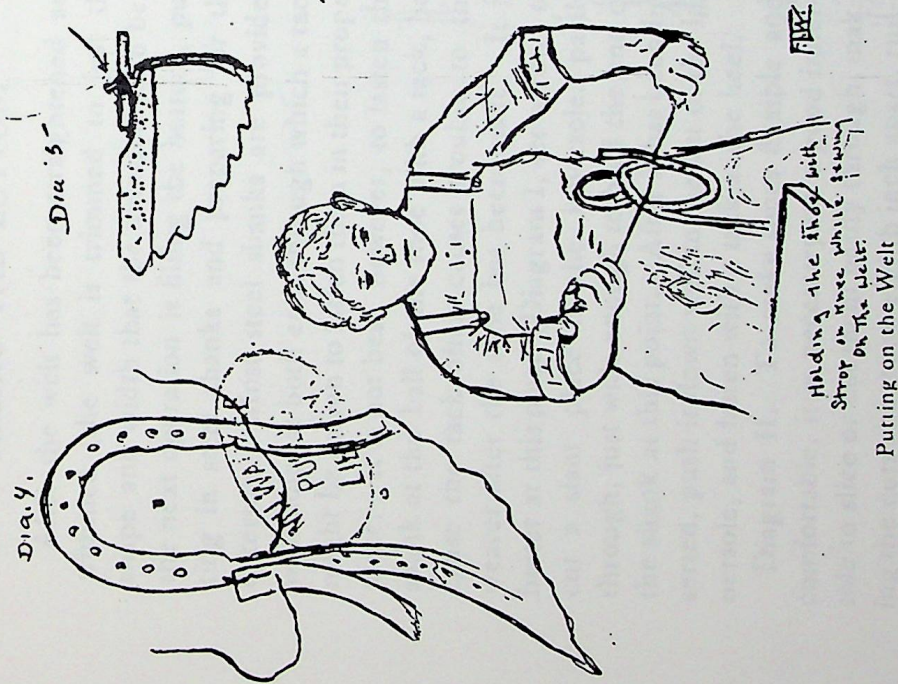

## FILLING THE BOTTOM

After the welt has been straightened and trimmed (the welt is trimmed to just the shape and width that the outsole is to be), the next operation is filling the bottom, putting in steel shanks and preparing for the outsole. Most steel shanks are provided with holes at both ends through which a tack might be driven to fasten them in their proper place. It is not best, however, to fasten the shank at the ball of the shoe with a tack, because the tack often causes trouble to the wearer after the shoe has been made. It is better at this place (Diagram I, see arrow) to cut a slant place in the innersole, partly through, just wide enough to hold the end of the shank at this point. After it has been inserted, push it down well to the last of the innersole, and fasten with a tack at the heel.

Diagram II. To make shoes flexible and comfortable, it is necessary on a good innersole to slice or cut them partly through, making the cuts about one-eighth inch apart, run-

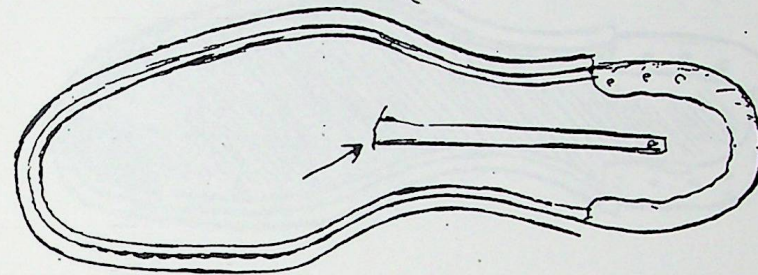

DiA. I

Putting in Steel Shank

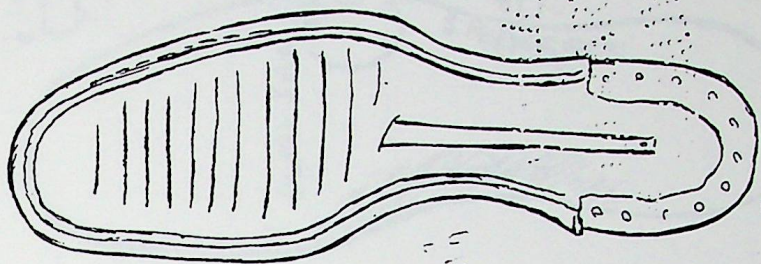

DiA. 2

Making the soles flexible

ning across the sole as shown in Diagram II. It is not necessary to slice the sole beyond the tip line because the shoes are not generally expected to bend at the toe. Next fill the space between the insole and outsole with tar felt as shown in Diagram III. This felt should extend over the whole innersole between the seams, and to avoid crying it should be put thinly over the bar all around.

Diagram IV shows the outside sole cut in shape and skived in the shank.

The outside sole is skived in the shank, not because a thinner or weaker shank is wanted, but because the shank, in order to look neat, is finished with a bevel edge. Take a piece of leather 1-4 inch thick and bevel a part of it; the edge on the beveled part will look to be thicker than the edge on the part that is not beveled. It is this apparent thickness that we wish to avoid. To overcome this, the part that is to be beveled in the shank must be trimmed enough to offset the thick appearance. See Diagrams C and D on opposite side of the sole.

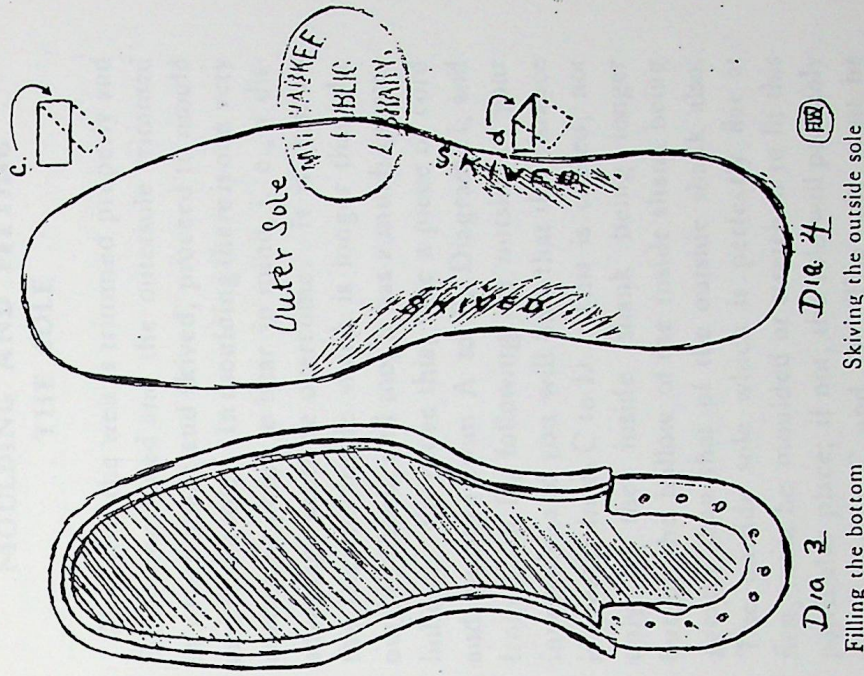

#### HOW TO BOTTOM A WELTED SHOE

The solid lines on Diagram C represent a piece of leather 1-4 of an inch thick. Notice the arrow pointing towards the square edge. The dotted lines on same diagram represent a thinner piece of leather beveled on the edge and show that beveling causes the thinner piece to look as thick at the edge as the thicker piece. The solid lines on Diagram D represent a thinner piece of leather beveled. The dotted lines on the same diagram represent a thicker piece of leather square on the edge and proves that beveling caused the thin piece of leather to seem as thick on the edges as the thick piece would look squared. The shank of the sole is therefore skived on the edges only when a beveled shank is desired.

#### MOULDING AND FITTING THE SOLE

Now that the welt is trimmed properly and the bottom filled and the outersole trimmed in rough shape and skived, proceed to mould and fit the sole. In moulding there is one very particular point to bear in mind, i. e., a disadvantage must be overcome. It is this: on the last the inside shank is longer than the outside shank, and too, it has a much greater hollow. To prove this, take a piece of cord and measure from A to B, Diagram II, and from C to D, following the outside of your innersole, and you will find that the distance is greater from C to D. This is caused, not only by the inside shank being longer but by the hollow of the inside shank being greater than that of the outside shank also. The outside sole which is perfectly flat at first, must be moulded or stretched to fit this particular place; if not, the sole will probably rip between C and D. The sole must be stretched at this point so that it will conform

easily to the shape of the last. Since the threads in the shank which hold on the outer-sole are generally put in at an angle, every care must be taken to see that this sole is well moulded, because the stitches when put in at an angle, cannot be as strong or hold as well as when put in perfectly square. The sole must also be molded to fit the ball, because the threads will have enough to do to hold it (the sole) in its place.

Making sure that the sole is properly skived and well moulded, proceed to fasten it to the shoe for trimming. First lay the sole on the shoe, hold it down well in the shank with the strap, just as the innersole was held; fasten the ball first, with one nail directly in center, and then the heel. Tap it all around with hammer to be sure it lays well to the welt. The nails should be placed: one in the center of the toe, one in the center of the ball at the shank line, two or as many as necessary in the heel seat. Begin to trim the sole on the inside of the shoe, and rough-trim the whole sole, after which trim the sole again

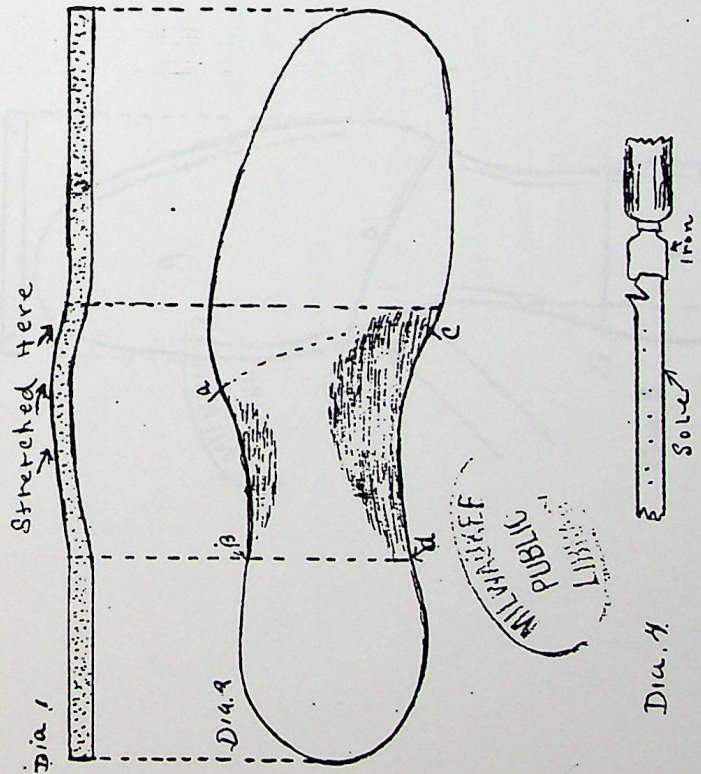

Moulding and fitting the sole

### HOW TO BOTTOM A WELTED SHOE

square to the welt around the forepart, next bevel the shank, beginning (to bevel) just around the shank and forepart line as shown in Diagram III, line A. Now round up the heel seat, leaving sole wide enough to work on. With the sole well trimmed, the next thing to do is to cut the channel. The channel is generally cut about 1-8 inch from the outer edge of the sole, or about the width of the guard of the iron with which the shoe is to be set up. See Diagram IV showing the iron with its guard resting at the edge of the channel. The channel is cut just as far from the bevel edge in the shank as it is from the square edge of the forepart. This 1-8 inch in the shank is left to work on when fitting the edge to the iron.

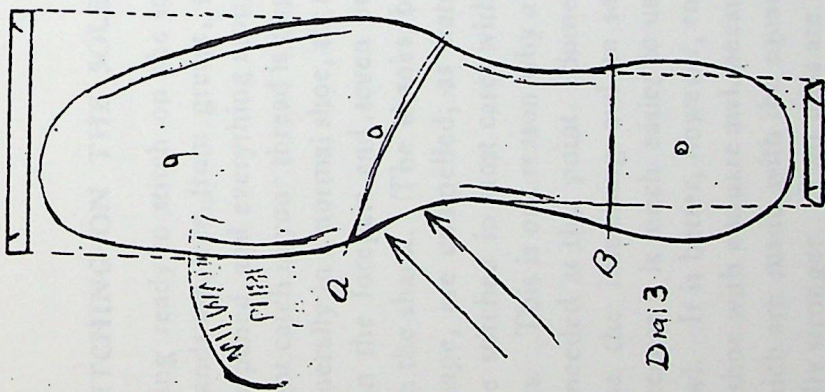
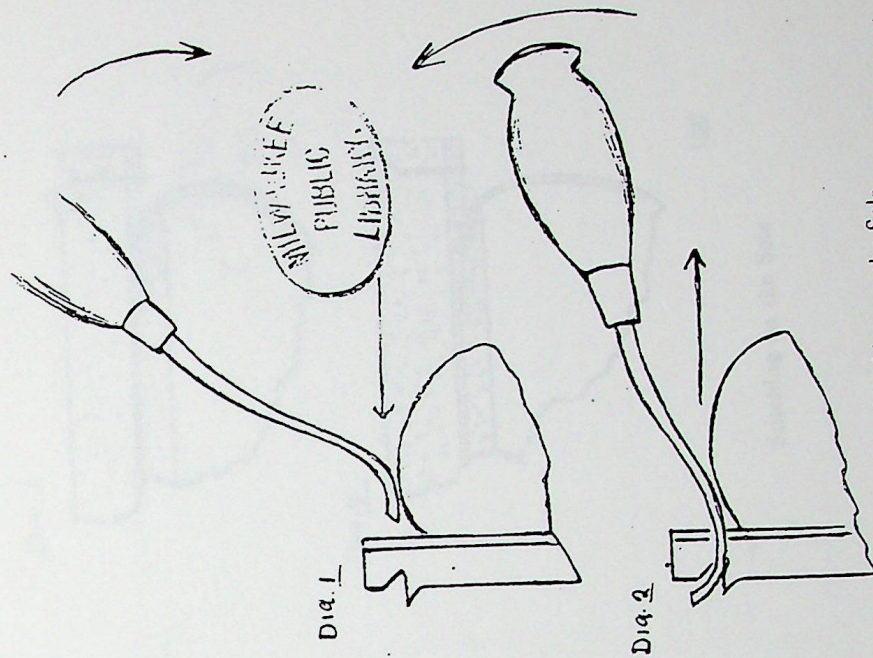

FIG. 3

Moulding and fitting on the sole

## STITCHING ON THE SOLE

In making ready to stitch on the sole, see that the hands are free from grease, the awl is well sharpened, and everything around you which might catch in your thread is out of the way. Generally in a normal shoe, six strands are used in the forepart and seven or eight are used in the shank. The shanks, because of their shape, are compelled, as stated before, to be stitched in most cases with slanting stitches. This is one reason why a larger thread is needed at this point. Some shoemakers use the inseaming awl to sew the shanks, because it is much easier to use than a square awl. It is better, however, to stitch the whole shoe with a square awl, because the stitches which are made with the square awl are generally stronger. Two awls are necessary: a larger awl for the shank, a smaller awl for the forepart. In either case, the awls should be smaller than both ends of threads when put together, because they (the threads) should be forced into the hole which the awl



Stitching on the Sole

## HOW TO BOTTOM A WELTED SHOE

has made. There is quite a slight in the use of the stitching awl; the blade of the stitching awl, being flat, is sure to break if it is twisted after it has been pushed into the sole. It is therefore necessary to push the awl in with two motions only; one is towards the welt, the other is a downward motion of the handle as shown by arrow in Diagram I. The awl should not be pushed further through than is necessary to make the hole large enough for the bristled part of the thread to be pulled through. The rest of the end is forced or pulled through and offers a resistance. The awl when pulled out is handled with two motions, just as it was when being pushed in, only backward. The straight arrow shows the motion of the blade in the sole, the curved arrow shows the motion of the handle which is held in the workman's hand.

If the hole is properly made it will remain square and insure a square stitch. The threads are generally overcasted on the welt; the length of the stitches is made to suit the taste of the workman. A good stitch in the sole is

Di a. 2

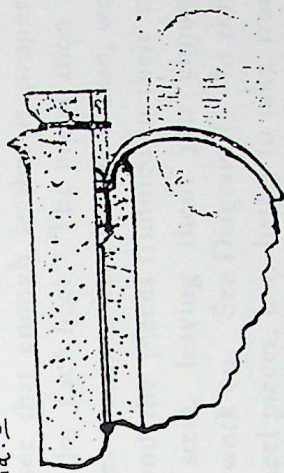

Di a. 4

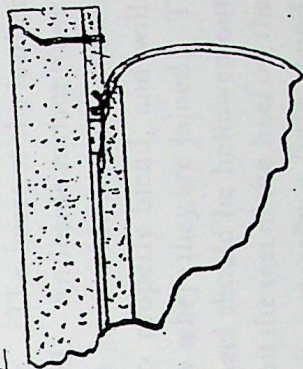

Di a. 5

Stitching on the Sole

about eleven to the inch; in the shank about nine to the inch. Diagram III shows the stitch in the sole and welt with the channel not closed.

To close the channel dampen the part that is turned back with a sponge. (It is best to dampen whole sole to avoid splotches.) With the back of the hammer rub it down diagonally all around, after which rub the whole bottom with the handle of the hammer or a rub stick. Never rub the stitches down in the channel with any instrument that will make the channel spread. If this is done it is extremely hard to make a neat job in closing. Diagram IV shows the channel after it has been closed.

After this see that the whole bottom is perfectly level while damp. Mold the shank well to shoe again.

## BUILDING THE HEEL

Before beginning to build the heel or to put the leather on the shoe for the heel, it is best to see that enough leather is properly prepared for each heel. The preparation of the leather means to have it well in case, well skived, and the pieces trimmed to their respective sizes, leaving them just enough larger to work on. See Diagram I. In skiving the heel pieces, it is better to take from them all meaty substances and all of the outside surface. The heart of the leather makes a better heel. An inside surface when put together with an outside surface will not allow the heel to properly blend, and will nearly always show where they are joined. The first tap of the heel should be hollowed out in the center to suit the seat of the heel on the outer sole which is generally a little round on the bottom, see Diagram III.

Some shoemakers skive the sole instead of skiving the first tap. Skiving the sole generally weakens the heel at the seat. It is bet-

## HOW TO BOTTOM A WELTED SHOE

ter, to let the main foundation, which is the sole, retain its whole strength by skiving the first heel lift instead. The first lift should be fastened to the sole with as many tacks as are necessary to hold it until it is roughly trimmed. See that this lift is level before putting on the remaining lifts. The remaining lifts, minus the top lift, are put on next with enough nails to hold them until they are roughly trimmed in shape. Next nail the heel down with nails long enough to clinch on the innersole. See if the heel will be level with the top lift, by placing the top lift under the heel and resting the shoe on a level surface. The heel at its proper height should allow the seat, or heel of the shoe at the bottom of vamp to be level. Next fasten the top lift to the heel and trim it the exact shape you wish the heel to be when finished. See Diagram 11. Next, nail it down, putting as many nails on the inside of the heel as are necessary to hold the tap in place. The outside of the heel should be nailed thick enough to protect the heel. The nails should be placed 1-8

47

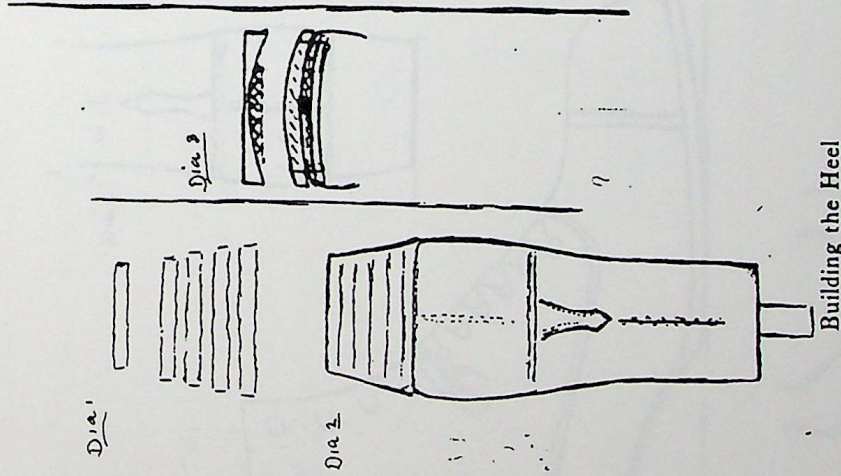

46

HOW TO BOTTOM A WELTED SHOE

inch from the edge of heel. Of course, if a person runs the shoe over from the inside, the nails should be changed to suit them. Diagram VII shows the difference in lasts, and how these lasts require different heels. The height of the instep of the last generally determines the height of the heel. The three outlines of Diagram VII show different heel seats; the distance from each heel seat to the floor line shows the height of each heel. When the heel is finished it should rest slightly on the breast (see Arrow B, Diagram V, side view of heel, and Diagram VI, rear view of heel) and not quite touch the floor at the back. This is to help, in walking, for if the heel should set perfectly flat on the floor, the effect in walking would be clubby, but by allowing the heel to rest, as shown in Diagram V, the walking will be more like rocking in a rocking chair.

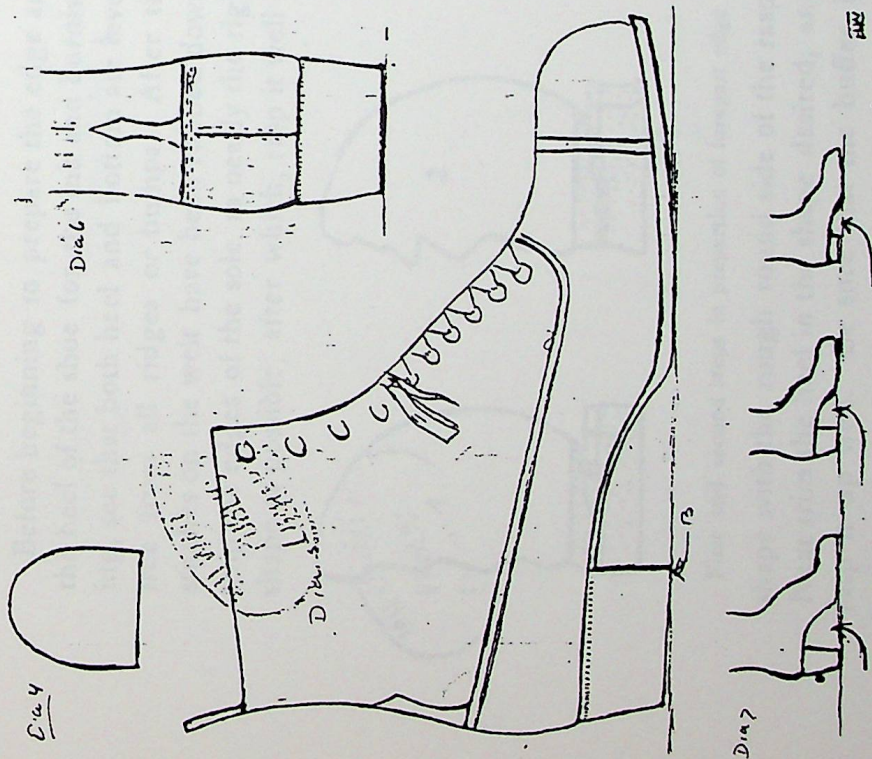

Building the Heel

## PREPARATION OF EDGES AND BOTTOM FOR FINISHING

Before beginning to prepare the edge and the heel of the shoe for the ink and burnishing, see that both heel and bottom are level, free from all ridges or bumps. After the stitches on the welt have been rubbed down, trim the edges of the sole as nearly the right shape as possible, after which, rasp it well in

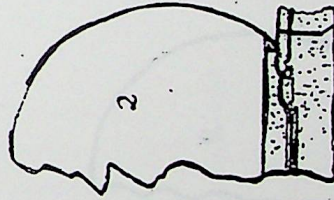
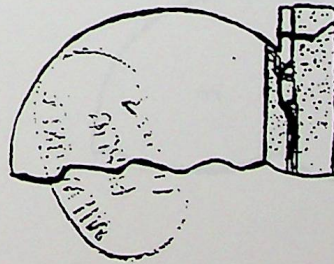

First and second steps in preparation of forepart edge shape with the rough round side of the rasp. Next trim the heel in the shape desired, and rasp it up well. Be sure that the buffer is

50

## HOW TO BOTTOM A WELTED SHOE

sharpened well. The idea is to make the edge of sole fit the iron which is convex. For this reason we are using the convex end of the buffer and side of the rasp, in order that the edge might be concave. With the buffer, buff the edge until it is smooth. See that the welt is trimmed with welt knife and rubbed

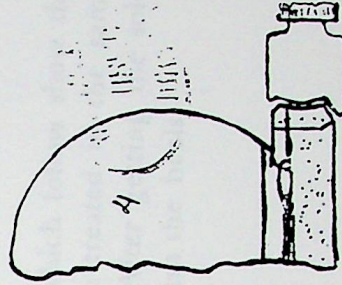
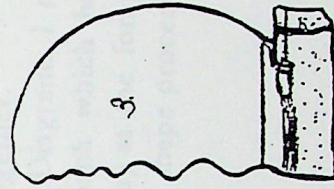

Third and fourth steps in preparation of forepart edge down smooth with the bone. Try the iron to see what or how much is to be taken from the edge of the sole on the bottom. Diagram III will show the sole and just how much will probably have to be taken from the outer side for the iron. This piece of sole is cut away

51

## HOW TO BOTTOM A WELTED SHOE

with the square point knife; sometimes with the lip knife. After the sole has been beveled on the edge to fit the iron, rasp it off lightly with the fine side of the rasp and then buff and sand-paper it. Diagrams I to IV show the different stages of the edge of forepart. Diagram IV shows the edge and iron together.

Diagrams I to IV which follow show the shank which has been treated in the same way as the forepart. After getting the sole in shape proceed to finish the heels.

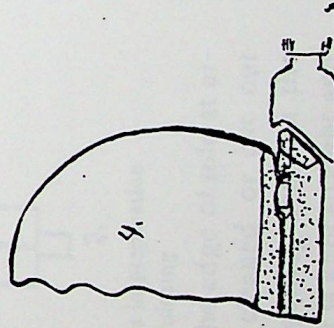
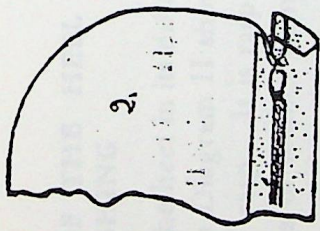

First and second steps in preparation of the shank edge

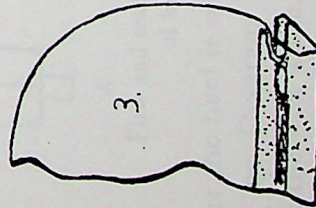

Third and fourth steps in preparation of the shank edge

### PREPARATION OF THE HEEL FOR FINISHING

Diagrams I to V show the heel in its different stages. The arrow on Diagram II shows the direction to push the rasp. It is rasped this way to make the layers of leather blend.

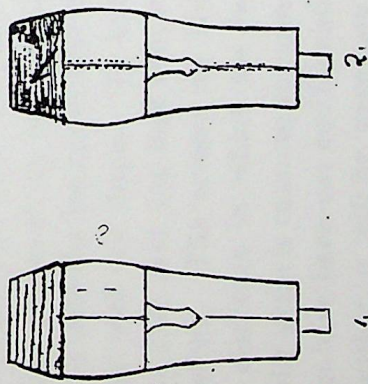

First and second steps in preparation of heel for finishing

After the heel is rasped the edge of sole at arrow on Diagram III is cleaned or cut out with the wet knife. In cutting see that the line beginning at the welt is kept straight and level all around the heel seat. The rhan break is used next at arrow 2 around the seat

of the heel to file the material close to the upper. Buff the heel down and sand-paper it until it is real smooth. Diagram V shows how the heel will appear when finished if properly cleaned.

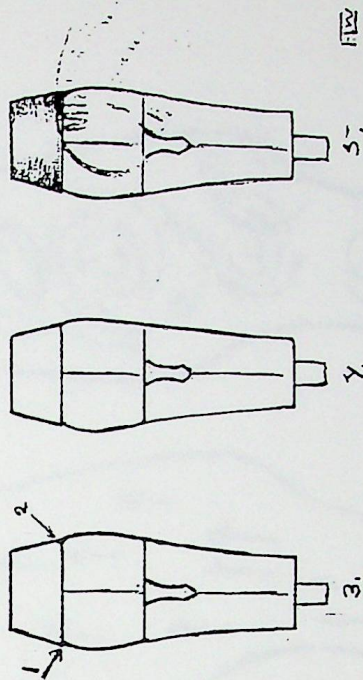

Third, fourth and fifth steps in preparation of heel for finishing

## BUFFING, CLEANING AND POLISHING THE BOTTOM

After having prepared the edges, the next thing in order is the cleaning of the bottom and making ready for ink. Be sure that the nails in the bottom of the heel are filed and rasped even with the leather so that they cannot be felt with the finger. In buffing the bottom, be sure that you buff with the grain of the leather. The arrows on Diagram I show the direction in which the bottom is buffed if the grain is running towards the toe. If the soles have been cut end for end, from a piece of leather, it will be necessary to buff the soles in different directions to suit the grain. After the bottom has been made as smooth as possible with the buffer, begin to sand-paper. It is best to sand-paper in circles on the bottom as indicated in Diagram II by arrows. Sand-papering straight up and down the bottom generally leaves scratches. To make the ink take well the bottom should be left like velvet. Two sizes of sand-paper

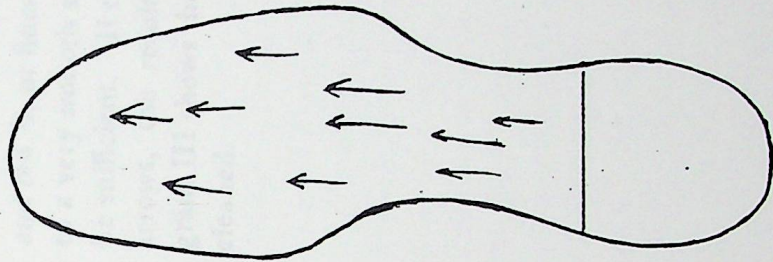

1  
Buffing bottom

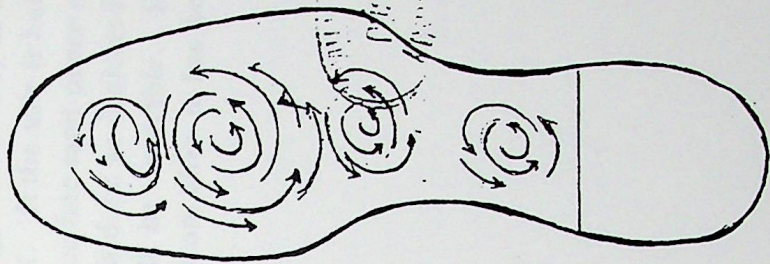

2  
Sand-papering bottom

### HOW TO BOTTOM A WELTED SHOE

should be used: the larger size (1 1-2) at first, and No. 0, or finer, last. If the sole is buffed to a very smooth surface fine sand paper may be sufficient. If this is done as indicated by arrows, the result will be favorable. Diagram III shows the bottom after it has been cleaned.

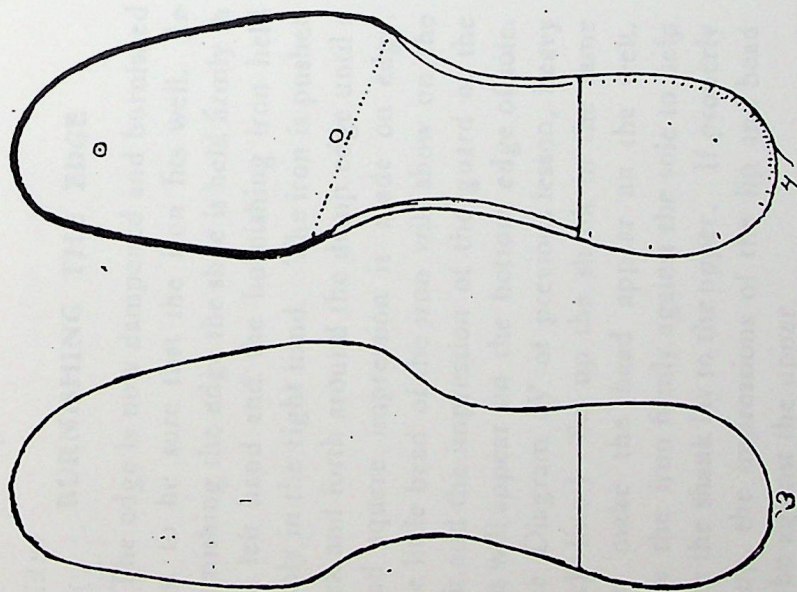

Bottom after being cleaned

Bottom after edges are set up. Shows impression of guard on outer edge

## BURNISHING THE EDGE

The edge is now dampened and burnished first to be sure that the iron fits well. In burnishing the edge the shoe is held firmly in the left hand and the burnishing iron held firmly in the right hand. The iron is pushed back and forth around the damp edge until a good square impression is made on edge. The little bead of the iron will show on the welt and the impression of the guard of the iron will appear on the bottom edge of sole. (See Diagram IV of previous lesson, heavy black line.) Set up the shank in the same way; make the bead appear on the welt. Press the iron firmly against the sole to help make the shank lay to the upper. If properly set up, the impressions of the lip and bead will be against the upper.

Next divide the stitches on the forepart with the stitch divider, being sure not to break the bead on the welt. Do not scratch against the upper with divider.

After stitches are divided apply burnishing

## HOW TO BOTTOM A WELTED SHOE

ink to the edge and let it set until mediumly dry. During this time the edge irons should be heating; when they are hot (enough only to dry water quickly when applied) brush the edge and proceed to burnish.

If a white or light bottom is desired, the bottom is cleaned after the edges are finished. A good finish at this stage will be a thin coat of liquid tan polish evenly distributed and rubbed down with the grain and left to dry. If a black bottom is desired, the shank slicker will have to be used to burnish after the ink has been distributed and the bottom may be cleaned before finishing the edge. Place the slicker on the lamp; while it is heating, distribute the ink evenly over the bottom. By the time the slicker or burnisher is warm enough for use, the ink will be about ready. The proper way to test the heat of the burnisher is by applying water from the sponge; if the burnisher is at a right temperature, the water will not spatter, but will simply dry on the burnisher gradually. Brush the bottom well and begin to burnish. Hold the shoe between

#### HOW TO BOTTOM A WELTED SHOE

the knees and rub lightly backward and forward, making sure the slicker does not stop abruptly at any point. After the ink has come to a shine, brush well again with the brush and rub briskly with a woolen cloth.

This will give the bottom a high polish.